

USER'S MANUAL



Planet Audio®

PI9759B

**Bluetooth®-Enabled
In-Dash Single -DIN AM/FM DVD/MP3/CD Receiver
with 7-inch Widescreen Touchscreen Digital TFT Monitor
with dual (front and rear) USB and SD Memory Port and AUX Input**



Planet Audio®

www.planetaudiousa.com

TELEPHONE
888.990.1236

FAX
805.988.0275

TECHNICAL SUPPORT
www.planetaudiousa.com/support

PI9759B 12.2012

all specifications subject to change without notice
© 2012 Planet Audio

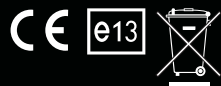

iPod® is a trademark of Apple, Inc.
registered in the U.S. and other countries

Planet Audio is not affiliated with Apple, Inc

CONTENTS

Panel Introduction 02

Basic Function 03

Remote Control Function 05

Turn on/off Host 07

Access main interface 07

USB/SD Card function operation 07

Radio Function Operation 08

Disc Function Operation 09

Play/Eject Disc 09

DVD/VCD Disc Playback 09

CD Disc Playback 09

MP3/WMA Format Disc Playback 09

Touch Menu Function 09

BT Function Operation 11

Music function operation 12

External input operation 12

Other function operation 12

Rear view function 12

Access setup interface 13

General setting 13

Time setting 13

Language setting 13

Video setting 13

Audio setting 14

Steering wheel setup 14

Touch calibration 14

Wiring Diagram 16

Trouble shooting 16

Specifications 17

Accessory 18

DVD Parental control function 18

Warning: To ensure safety while driving and to comply with laws, drivers should not watch video or operate the video device while driving.

ACCESSORY

Accessory	Quantity
Wire	1PC
USB Cable	1PC
Remote Controller	1PC
Warranty card	2PCS

DVD Parental control function

DVD Parental control function

*DVD Parental control function: The default set for DVD is #8 adult, which means all grades of DVD can be read without entering password. To change the default grade, you need to follow the below procedure: Press SETUP button on the remote, display will show the system set up menu and the submenu, select password and enter 0000, you will be able to choose the DVD grade as default.

SPECIFICATIONS

Power supply	DC 12V
Power range	10.8-16.0V DC
Max operate current	15A
Ground system	Negative ground
Amp Rating	85 WattsX4 Channels

FM tuner

European frequency range	87.5-108MHz
USA frequency range	87.5-107.9MHz
Signal / Noise ratio	55dB
Stereo separation	30dB
Search station volt	20-30dBuv
Distortion rate	1.5%

AM tuner

European frequency range	522-1620KHz
USA frequency range	530-1710KHz
Limit noise sensitivity	32dB

DVD player

Signal / Noise ratio	70dB
Frequency response	20Hz-20KHz

This unit is with switchable frequency.

You can switch from USA frequency to Europe frequency by following the below steps:

Step1. In main menu, press setup icon to enter the setup interface.

Step2. Press the Radio icon, and insert password 123456, then press "OK", the menu from which you can select the radio frequency will show.

Step3. Press "Radio region" and select the desired frequency by pressing the "up" and "down" arrow, then press it and setting is finished.

PANEL INTRODUCTION

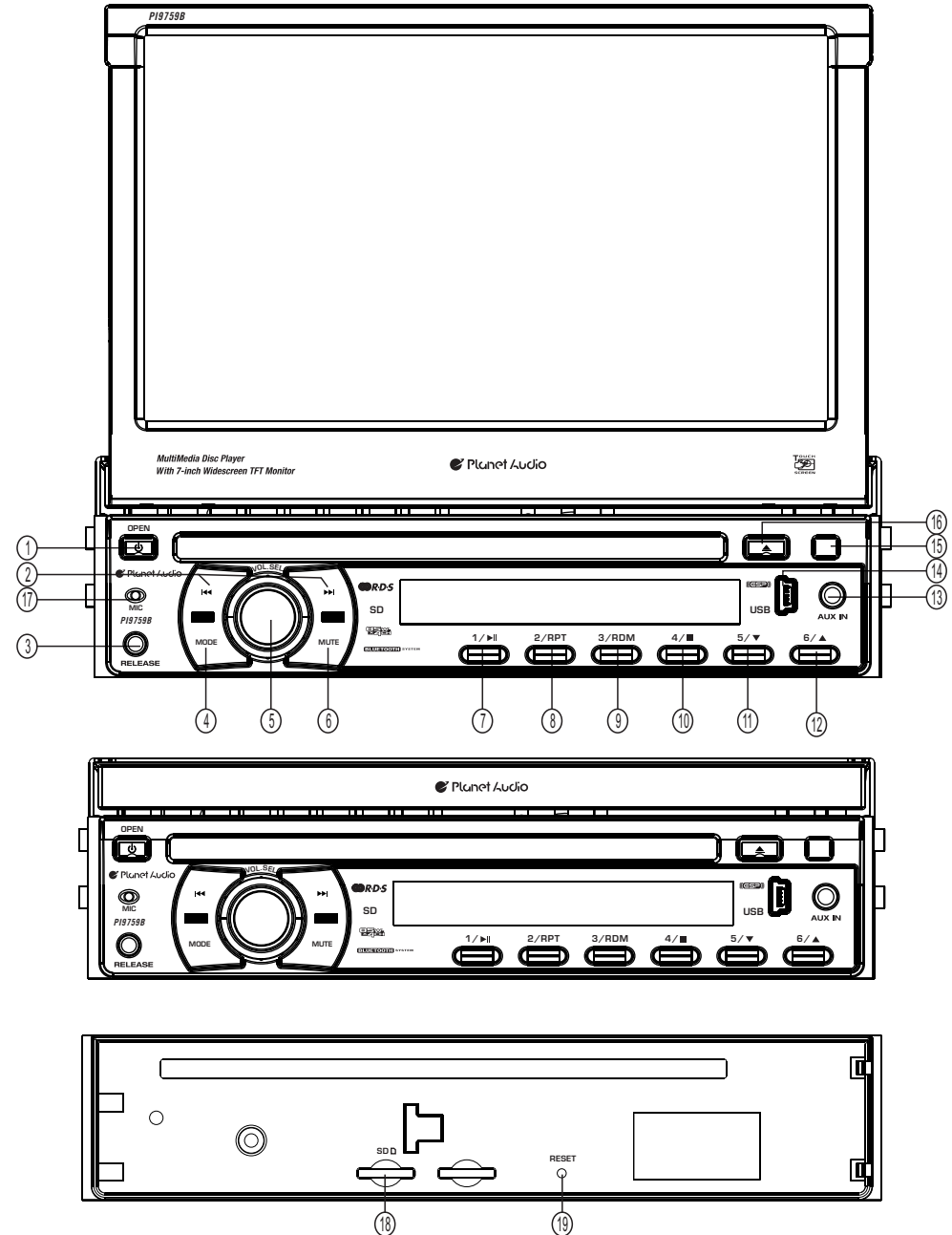

BASIC FUNCTION

1. /OPEN Button

Press the button to open / close the screen.

Press this button for short moment to turn on power, and long press it to turn off power.

2. SEEK Knob / / / (SEEK+ / SEEK-) / (SEEK / SĒEK)(Speed forward / backward / Select station / song)

In radio mode, press / rotate the knob to select station upward / backward.

Long press / rotate the knob to automatically scan station.

In playback mode, short press / rotate the knob to select song upward / backward, long press / rotate it to achieve speed forward / backward function.

3. RELEASE Button

Press this button to release the panel.

4. MODE Button

When the unit is power on, Repeat press this button can switch to different function mode as following picture.

Note: When the device without connecting to USB、SD or DVD no disc inside, the system will automatically skip these related working mode.

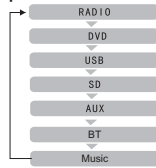

5. (VOL/SEL) Volume adjustment mode

Repeat pressing this button can select the VOL、BAS、TRE、BAL、FAD adjustment mode,

Then can rotate the button to adjust VOL、BAS、TRE、BAL、FAD as you like.

6. MUTE Button

Press this button to shut off sound output, repress this button to resume sound output; Long press this button longer to turn on / off TFT LCD display.

7. Number Button 1 /

In radio mode, press this button to hear radio preset;

In disc playback mode, press this button for Play/Pause.

8. Number Button 2 / RPT (Repeat Playback)

In radio mode, press this button to hear radio preset;

In disc playback mode, press this button to repeat the current track indefinitely.

9. Number Button 3 / RDM (Random playback)

In radio mode, press this button to hear radio preset;

In disc playback mode, press this button to play tracks on the disc in random order.

10. Number Button 4 /

In radio mode, press this button to hear radio preset;

In disc playback mode, press this button for to stop playback.

WIRING DIAGRAM

This player is equipped with ISO standard connector, please follow below instruction:

- Red - ACC ON (+12V)
- Yellow - 12 V Constant
- Black - Ground wire
- Blue - Power Antenna / Remote Amp Turn On
- Orange - Back-Up Camera Trigger (+)
- Grey/Grey black - Right front speaker (+/-)
- White/White black - Left front speaker (+/-)
- Purple/Purple black - Right rear speaker (+/-)
- Green/Green black - Left rear speaker (+/-)
- Pink - Parking Brake (-)

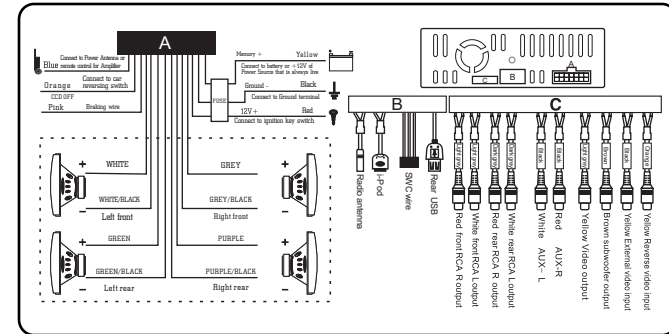

TROUBLE SHOOTING

PROBLEM	CAUSE	SOLUTION
Cannot power on	Check fuse	Change fuse same as the old one
	Some factors cause MPU wrong operation	Press RES button on the panel by penpoint, then, power on
After ignition switch off ,setting information all lose	Change battery or fuse	Reset information and save
Poor performance of radio station	Weak signal	Move the car to another place, then research
Cannot load disk	There is a disk inside	Remove disc before inserting another one
	Disc is scratched	Change new disc
	Put wrong side of disc into the unit	Insert in the disk with sign side up
Cannot play disc	Lens is dirty	Clean lens by lens clean disc
	There is only one language/ subtitle in disc	If disc is not with multi-language/subtitle, it cannot switch language/subtitle
Cannot switch language/subtitle	Other factors cause MPU wrong operation	Press [RES] button on the panel by penpoint, then, power on
No image	It's not allowed to watch image during driving	Park the car in a safe place, put the car stall in "P" position, pull up the hand brake, parking brake wire must be grounded

Calibration to re-gain touch

✦ Please follow the below instructions to calibrate when there is no touch or touch is not accurate.

Step 1: Press the mode button in the unit to switch to DVD mode.

Step 2: Insert a DVD disc, after DVD is loaded, press the stop button “” (as show in picture 1.) in the remote short, the unit will display as show in picture 2.



Picture (1)



Picture (2)



Step 3: Press “” in the remote as show in picture (3), the unit will display as show in picture (4)



Picture (3)



Picture (4)

Step 4: Press “” button in the remote and then quickly press “” button as show in picture (5) and you will enter the touch calibration interface as show in picture (6).

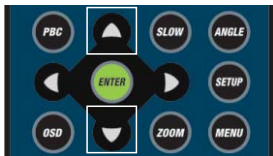

Picture (5)

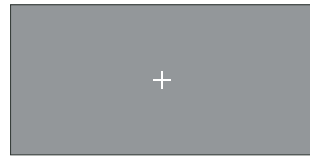

Picture (6)

Step 5: Use the touch pen to touch the center of the cross cursor, the cross cursor will move from the center to top left corner, top right corner, right down, left down, when the cross cursor stop at each corner, touch the center of the cursor. Then the panel will display OK and leave the calibration interface and the unit regained touch as show in picture (7).



Picture (7)

11. Number Button 5 / ▼

In playback mode, press the button to adjust the angle of screen.

12. Number Button 6 / ▲

In playback mode, press the button to adjust the angle of screen.

13. Dual (front and rear)AUX

To input external audio.

⚠ Warning : You can only use either front or rear AUX at a time. Never connect both front and rear AUX at the same time.

14. Dual (front and rear)USB

Insert USB removable advice so as to read audio/video files.

⚠ Warning : You can only use either front or rear USB at a time. Never connect both front and rear USB at the same time! This could cause malfunctions.

15. IR

To receive infrared signal from the remote control.

16. ▲

When there is a disc in the unit, press the button to eject the disc.

17. MIC

BT microphone input socket.

18. SD

Insert SD card, the unit will play the files automatically.

19. RESET

Press this button and this unit will be restored to the initial state.

REMOTE CONTROL FUNCTION

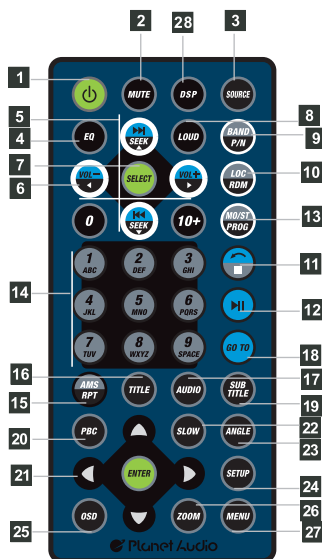

1 POWER ON/OFF	15 AMS / RPT
2 MUTE	16 TITLE
3 SOURCE	17 AUDIO
4 EQ	18 GO TO
5 SEEK+ / SEEK-	19 SUB TITLE
6 VOL+ / VOL-	20 PBC
7 SEL	21 UP / DOWN / L / R ENTER
8 LOUD	22 SLOW
9 BAND / P / N	23 ANGLE
10 LOC / RDM	24 SETUP
11 STOP	25 OSD
12 PLAY / PAUSE	26 ZOOM
13 ST / PROG	27 MENU
14 O-10+	28 DSP

1. POWER

Press once to switch on, press again to switch off.

2. MUTE Button

Press once to turn off audio output, press again to resume volume level.

3. SOURCE Button

Press this button to change mode.

4. EQ Button

Press this button to choose POP、ROCK、CLASSIC、EQ off.

5. SEEK+ (▶▶) / SEEK- (◀◀) Button

In normal playback MP3、USB、SD songs, Press this button to previous song or next song.

6. VOL+ (→) / VOL- (←) Button

Press this button to increase or decrease volume level.

7. SEL Button

Press this button to choose sound feature.

8. LOUD Button

Press this button to startup LOUD function.

9. BAND-P/N Button

In radio mode, press this button to choose band.

In VCD、DVD mode, press this button to choose PAL、AUTO or NTSC system.

10. LOC/RDM Button

In radio mode, press this button to switch between local and direction.

In VCD、CD mode, press this key to randomly play.

11. STOP Button

Press this button to stop playing.

12. PLAY/PAUSE Button

Press this button to switch between play and pause.

In stop mode, press this button to play.

13. ST/PROG Button

In radio mode, press this button to choose stereo or mono station.

In audio mode, it can help STOP button to programmed play.

Audio setting

Click icon on setup interface to access audio setting interface, as shown in right(PIC 1) diagram:

You can turn on or turn off the existing functions on audio setting interface.



PIC 1

Steering wheel setting

I. Click icon on setup interface so as to access steering wheel setting interface.

II. Connect anode and cathode of direction control wire of the car with anode and cathode of direction control wire of this device, and press the buttons on steering wheel one by one and record the corresponding sequence and functions.

III. Click the button of steering wheel needs to be allotted so as to select the corresponding setting function, such as volume +.

III. Buttons on steering wheel shall display the corresponding functions, such as volume +.

- To modify function settings, repeat procedures 3~4.

- To reset functions, click [Reset] icon, all the settings set before shall be cleared, repeat procedures 3~4 for resetting.

Touch calibration

If touch calibration error occurs, you can adjust the touch coordinate by "Touch calibration".

Click icon on setup interface, input password [888888] to confirm to access touch calibration interface, as shown in below diagram:

Touching methods

Use touch pen to click the center of "+" icon, and move along with center of "+" icon so as to calibrate the screen. It shall automatically save data and exit after screen calibration. Please accurately click all positions on screen, or the accuracy of touch calibration shall be affected.

Access setup interface

Click [Setting] icon on main interface to access setup interface.

General setting

Click icon on setup interface to access general setting interface, as shown in below PIC 1 diagram:

In general setting interface, you can select to turn on or turn off the existing functions. You can set wallpaper and opening picture you like and check version number of DVD/MCU, click icon to browse up/down.

Wallpaper selection

Click icon on wallpaper bar , direction icon shall pop up, click it to select wallpaper.

Time setting

Click icon on setup interface to access time setting interface, 12h/24h interchangeable, as shown in below PIC 2 diagram:

Click icon on time bar time setting interface shall display, as shown in below PIC 3 diagram:

Click icon beside hour and minute to separately set hour and minute.



PIC 1



PIC 2



PIC 3

Language setting

During use, you can select your familiar language to display menu by language setup. Click icon on setup interface to access language setting interface, as shown in right (PIC 4) diagram:

Click the corresponding icon on the language bar desired to be set so as to switch the language type, when there are more than 3 languages, direction icon shall pop up, click it to select your familiar language.

Video setting

Click icon on setup interface to access video setting interface, as shown in right (PIC 5) diagram:

At video setting interface, you can adjust brightness, contrast, saturation and hue of the video.



PIC 4



PIC 5

14. 0-10+ Button

Press this button to choose desired song, section, preset stations. Decimal numbers, for example the 19th song, press 10+ and 9 button.

15. AMS / RPT Button

In radio mode, press this button to browse stored stations. In audio mode, press this button to play repeatedly.

16. TITLE Button

In DVD mode, press this button to play back to the top menu of disc.

17. AUDIO Button

In DVD mode, press this button to switch language of dialogue. In VCD mode, press this button to choose left track, right track and stereo.

18. GO TO Button

In DVD mode, press this button, you can define playing time.

19. SUB TITLE Button

In DVD mode, press this button to switch language of subtitle.

20. PBC Button

In VCD mode, press this button to display all song menus, work with number button to choose songs.

21. UP、DOWN、LEFT、RIGHT、ENTER Button

When playing MP3、USB、SD returns to song menu, up、down selections can be up / "" button or down / "" key to select up and down, select and press "" key to confirm. The selected tracks can be played. Press the left or right arrow keys to "" or "" key, can be on the next page function operation.

22. SLOW Button

In audio mode, press this button to slow backward and slow forward.

23. ANGLE Button

In DVD mode, press this button to change play angle.

24. SETUP Button

In audio mode, press this button to choose different set items.

25. OSD Display

Press this button to display the title chapter and the left time.

26. ZOOM Button

In DVD/VCD mode, press this button to ZOOM in.

27. MENU Button

Press button to back to the main menu.

28. DSP

Press this button to show the time.

BATTERY CHANGE

When control distance of remote control becomes shorter or no function, please change battery. Please confirm polarity before change.

One hand press stopper, then pull out battery.



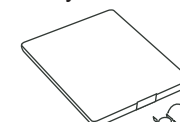

Put battery into controller.

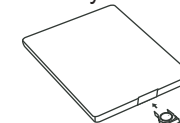

Insert battery holder into controller.



Turn on/off Host

When the ignition switch is put in ACC or ON position, Press [] button on the front panel to turn on the unit. After the host starts, hold [] button for 3 seconds, the host will turn off.

Access main interface

In the other mode, click on the interface to return the icon will switch to the main interface.

Touch the function icons so as to access the corresponding function operations.



USB/SD Card function operation

When there is a USB device/SD card connected, the unit can conduct the playback of audio/video/image files in the USB device/SD card.

Insert/Eject USB storage device

1. Connect a USB recorded with media information to the unit by a USB connecting cable.
2. When there is a need to eject the USB device, exit the USB device playback screen first, and then take out the device.

Insert/eject SD card

1. Insert a SD card recorded with media information into the SD card slot in the unit correctly until it is locked.
2. When pulling out the SD card, exit SD card playing state first, then press the SD card and it shall pop up after unlocking.

Enter/exit

Insert a USB storage device or SD card to automatically play data contained in it. If the unit has connected with a USB device or SD card, touch [USB] icon in the main interface to enter into the external storage playback interface; Touch [SD] icon to enter into the SD card playback interface. During playback, touch the top center area of the screen to pop up the touch menu, operate touch menu to perform various playback controls.

Play

After SD card/USB removable device being read out, the operation methods are similar to disk operation methods.

Music function operation

Connect to Music first, touch [Music] icon on main interface to access Music interface, as shown in below diagram.

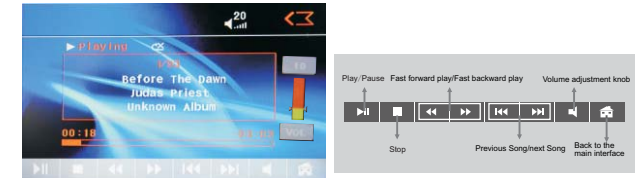

External input operation

Connect the video input plug with external video input jack, and connect the audio input plug with external audio input jack.

Touch [AUX] icon on main interface to access external input interface.

Audio – You can adjust the volume, bass, pitch for input audio.

You can adjust the speaker volume by adjusting the front and back, left and right column.

Video – You can adjust the brightness, contrast, saturation and hue for input video.

You can also choose the video standard mode.



Warning: In AUX mode, you can adjust the angle of screen by press region 1 & region 2. Press Region 1 to slide up, press Region 2 to slide down.

Other function operation

Rearview function

In any running state, the video signal can switch to reverse video state when reversing the car, and the system shall return to its initial running state after reversing the car.

⚠ Warning

Do not rely on CCD system completely, please make sure you use direct eyesight while driving. Back rearview system only assists in driving. As the distance range of rearview system is limited, completely relying on the rearview system during driving may cause accidents.

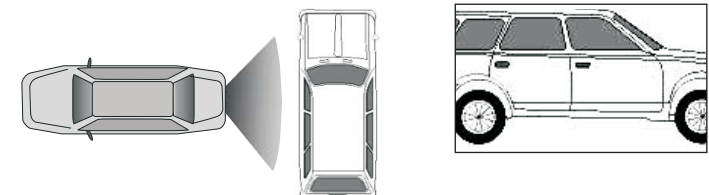

Reverse field simulation

Rearview backup image

BT Function Operation

★ Enter/exit

Touch [BT] icon in the main interface to enter the BT interface.

Touch  icon to exit BT interface.

★ Pair/link

To use BT hand-free function, make connection first, i.e. match the host with the BT mobile phone.

Operation methods:



Set the host to be matching state, and open the BT of your mobile phone and use the mobile phone to search device, the mobile phone shall prompt to match password with the BT when it has searched the BT device.

Input BT password (0000) to the mobile phone and confirm. The mobile phone shall prompt whether authorize to this device, please select [Yes]. Phone and BT shall automatically connect within 20 seconds. Under any working mode, the host shall convert to BT state if there is an incoming call. And the host shall restore to current mode after hanging up.

 When the BT device matches with this device, the connection status shall display “ LINK OK ”, otherwise, it shall display “ NO LINK ”.

★ Dialing

You can dial on mobile phone directly or input phone number through the number buttons on the screen, click  to delete if there is input error.

After input the phone number, click  to make a call, and click  to hang up the phone.

Click  during a call so as to switch the voice between car speaker and mobile phone.

★ Call records

Click  to access call records interface as below PIC 2:

Received calls: Touch this button to check all the phone numbers of received calls.

Dialed numbers: Touch this button to check all the dialed phone numbers.

Missed calls: Touch this button to check all the phone numbers of missed calls.

★ BT volume

Click  to access BT volume interface as below PIC 3:

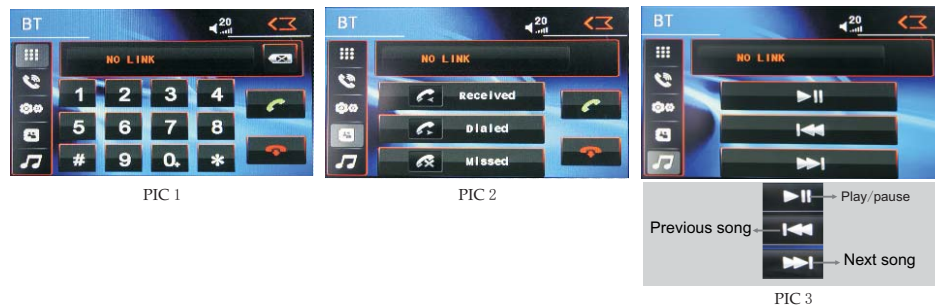

Radio Function Operation

★ Enter/exit

Touch [RADIO] icon in the main interface to enter into the radio interface.

Touch  icon to return to main interface, and then touch other function icons so as to exit radio mode.

★ Band selection

Click [BND] icon so as to switch among FM1, FM2, FM3, AM1, AM2 bands.

★ Search/Save radio stations

- Short press [Scan] icon to browse the stored radio stations.

- FM band can save 18 radio stations (Six stations for FM1/FM2/FM3), AM band can save 12 radio stations (Six stations for AM1/AM2).

★ Scan radio

Short press  icon to manually fine-tune radio stations upward/downward.

Long press  icon to automatically search and save radio stations.

★ Sound setting

Click [EQ] icon can switch to different sound mode.

★ Mute on/off

Click [Mute] icon to turn on/off mute function

★ TFT on/off

Click  icon to turn off TFT, and then click the screen area so as to turn on TFT.

Click  icon so as to slide screen angle.

RDS Function

RDS function provides series information (such as traffic information, name of station), and can automatically switch to the station with stronger signal and carries the same program.

 AF: Touch the button to turn on/off AF mode

 TA: Touch the button to turn on/off TA mode

 PTY: Touch the button the screen displays program types, users can search station according to program type

 If the unit does not have RDS function, it has no AF/TA/PTY function. The corresponding icon appears grey.



Disc Function Operation

★ Play/eject disc

Play disc

Insert the disc into the disc slot with the printing surface up, system will detect the disc and automatically take it in to read and play.

Eject disc

(1) Click [▲] button on the panel to eject the disc.

(2) If a disc has not been taken away 15 seconds after it is ejected, system will automatically take in the disc but not play.

▲ **Do not insert two discs or more.**

★ DVD/VCD disc playback

During playback of disc, touch the middle lower area of the screen to pop up the touch menu, operate the touch menu to perform various playback controls. (PIC 1)

★ CD Disc Playback

After a CD is inserted, system shall access disc reading state immediately.

When there is a disc in the device, click [Disc] at the main interface so as to access disc reading state.

After the disc being read out, system shall automatically play in sequence.

★ MP3/JPEG/MPEG4 disk playing

When the disc contains readable files, such as MP3/JPEG/MPEG4 files, it shall be automatically read out and played after slipping into DVD player.

During playing, touch the screen area and the touch menu shall pop up. Operate the touch menu for various playing.

★ Touch Menu Function Description

▶|| — Play/pause

Touch the button to pause, retouch it to continue to play.

■ — Stop

Touch the button to enter into prestop status.

◀▶ — Fast forward/backward

Consecutively touch this button to select the speed of fast-forward/fast-backward.

◀▶ — The previous/next song

Touch the button to select the previous/next song.

◀ — Volume adjustment button

Touch this button and volume adjustment modulation shall pop up, touch ◀▶ button to adjust the volume.

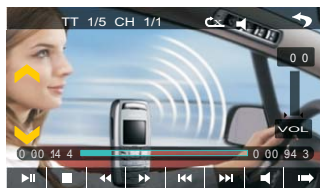

PIC 1

☰ — Access next menu

Touch it to access the next menu interface.

⌚ — Time setting

Touch this button to access time setting interface.

◀▶ — Stereo on/off

Touch it so as to turn on/off stereo.

☰ — Return to root menu

Touch this icon, it shall return to root menu of disk in DVD state and access PBC menu playing in VCD state. All chapters in the disk shall be displayed on the interface, touch the chapter icon directly for playing.

☰ — Access title menu

Press this button to return to title menu of the disk. Directly click menu bar at title menu interface for playing.

🔄 — Repeat play

In playing state, touch this button to start repeat play function: Chapter repeat — Title repeat — Repeat All — Off.

☰ — During VCD playing, this function only works when PBC is off.

🗨️ — Language selection

Touch this button to select language.

☰ — Digit keyboard

Touch this button and digit keyboard shall appear, click number buttons directly to select tracks for playing.

🎲 — Randomly play

Touch this button to instantly play each song. Press again to back to the normal play.

🔍 — Zoom in/Zoom out image

Touch this button to zoom in /zoom out the image.