

USER'S MANUAL



www.planetaudiousa.com

TELEPHONE
888.990.1236
805.988.0215

FAX
805.988.0275

TECHNICAL SUPPORT
www.planetaudiousa.com/support



Planet Audio®

P9692B

Bluetooth®-Enabled
In-Dash AM/FM DVD/MP3/CD Receiver
with 3.2-inch Widescreen TFT Monitor
with USB and SD Memory Ports and Front Panel AUX Input

P9692B 01.2014

all specifications subject to change without notice
© 2014 Planet Audio



To ensure safety while driving

and to comply with laws,

drivers should not watch video or

operate the video device while driving.

WARNINGS

► When Driving

Keep the volume level low enough to aware of the road and traffic conditions.

▲ CAUTION

In some countries, it's unlawful to operate a vehicle while video is displayed in the driver's viewing area. Please always switch the unit's display to "Font Type Display" mode by pressing the DISP button while driving.

For safety reason, the driver should only enjoy / watch the video while the car is in parking mode.

► When Car Washing

Do not expose the product to water or excessive moisture. This could cause electrical shorts, fire or other damage.

▲ CAUTION

In order to avoid any accident, the driver must not watch video while driving. This unit is designed to not allow watching moving video while driving. Park your car in a safe place and engage the 'PARKING BRAKE WIRE' before watching moving video.

► When Parked

Parking in direct sunlight can produce very high temperatures inside your vehicle. Give the interior a chance to cool down before starting playback.

► Use the Proper Power Supply

This product is designed to operate with a 12 volt DC, negative ground battery system (the regular system in a North American car).

► Protect the Disc Mechanism

Avoid inserting any foreign objects into the slot of this player. Failure to follow this may cause malfunction or permanent damage due to the precise mechanism of this unit.

▲ CAUTION

THIS MOBILE MULTIMEDIA PLAYER IS A CLASS I LASER PRODUCT. THIS UNIT USES A VISIBLE/INVISIBLE LASER BEAM WHICH COULD CAUSE HAZARDOUS RADIATION IF EXPOSED DIRECTLY. BE SURE TO OPERATE THE MOBILE MULTIMEDIA PLAYER CORRECTLY AS INSTRUCTED.

USE OF CONTROLS OR ADJUSTMENTS OR PERFORMANCE OR PROCEDURES OTHER THAN THOSE SPECIFIED HEREIN MAY RESULT IN HAZARDOUS RADIATION EXPOSURE.

DO NOT OPEN COVERS AND DO NOT REPAIR BY YOURSELF PLEASE REFER SERVICING TO A QUALIFIED TECHNICIAN.

NOTE:

1. TO REDUCE THE RISK OF FIRE OR ELECTRIC SHOCK, DO NOT EXPOSE THIS EQUIPMENT TO RAIN OR MOISTURE.
2. TO REDUCE THE RISK OF FIRE OR ELECTRIC SHOCK, AND ANNOYING INTERFERENCE, USE ONLY THE RECOMMENDED ACCESSORIES.
3. THIS DEVICE IS INTENDED FOR CONTINUOUS OPERATION.

DISC AND FORMAT SUPPORTS

This unit can play various video/audio format which stored into Disc/USB or SD card on Media Player.

The following chart helps you to check if a disc is supported by this unit, as well as what functions are available for a given disc type.

Disc format
Digital Versatile Discs (MultiMedias)
Video CDs (VCDs)
Digital Versatile Discs Recordable (MultiMedia +/-R)
Digital Versatile Discs Rewritable (MultiMedia +/-RW)
Compact Discs (CDs)
CD Recordable (CD-R)
CD Rewritable (CD-RW)

Audio Format

Playback CD-DA and MP3 or WMA digital music file on CD-ROM or MultiMedia- ROM or USB or Memory Card.

Note of MP3 and WMA:

Support Maximum 2000 files
 Maximum 30 characters display
 Supported Sampling frequencies; 32kHz, 44.1kHz, 48kHz.
 Supported Bit-Rates: 64-256 kbps variable bit rate

Video Format

Playback IMAGE JPEG, DVD Video, MPEG4 . On CD-ROM or Multimedia - ROM or USB or Memory Card.

Noted of MPEG4

Supported decoding MPEG-4 video defined by ISO 14496-2 Standard:

1. Simple Profile (SP) and
2. Advance Simple Profile (ASP)

Supported file format: MP4 and .M4a (audio only)

Unsupported Discs

8 cm Disc
 CDV, CDI, CDG,
 LD
 MultiMedia RAM

Note on Region Code

MultiMedia players and MultiMedia Video discs Have their own Region Code numbers. This unit Can play the disc of all region code numbers.



Disc Maintenance

Before playing, wipe the disc using a clean cloth, working from the center hole towards the outside edge.

Never use benzene, thinners, cleaning fluids or anti-static liquids or any other solvent.



NOTE

A disc may become somewhat scratched (although not enough to make it unusable) depending on you handle it and conditions in the usage environment. Note these scratches are not an indication of any problem with the player.

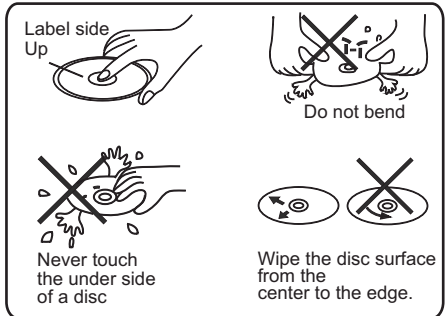

INSTALLATION

The following illustration shows a typical installation. If you have any questions or require information regarding installation kits, consult your customer car audio dealer or a company supplying kits.

If you are not sure how to install this unit correctly, have it installed by a qualified technician.

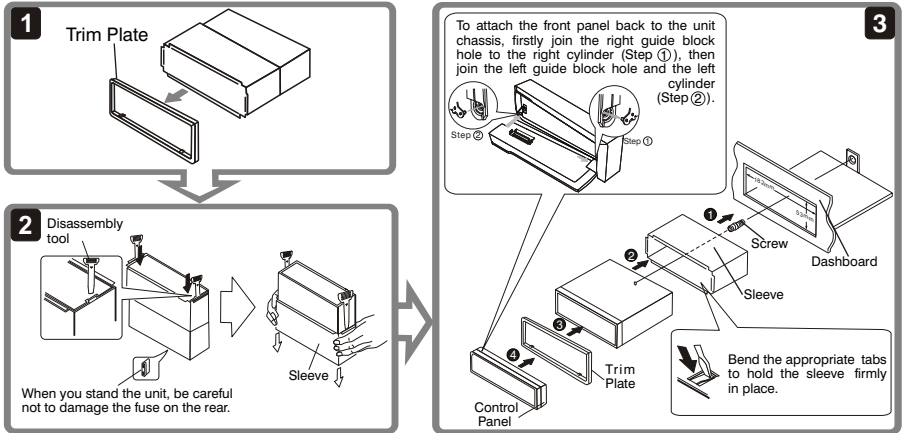

Removing the unit

Before removing the unit, release the rear section.

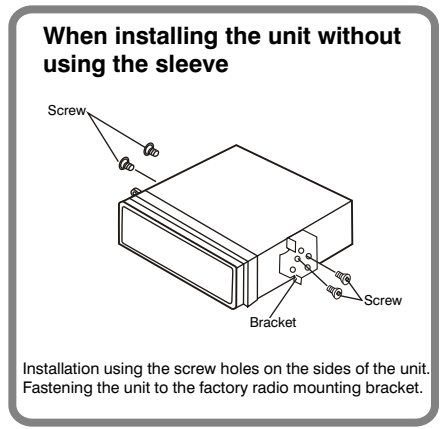
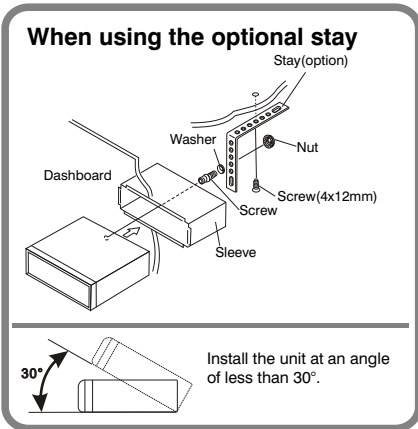
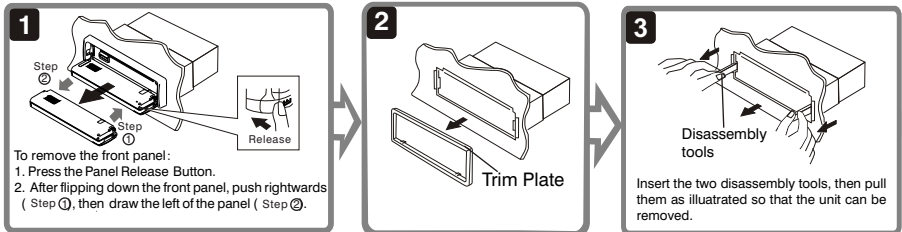

CONNECTING THE SYSTEM

About Parking Wire

▲ CAUTION

In order to avoid any accident, the driver must not watch video while driving. This unit is designed to not allow watching moving video while driving. Park your car in a safe place and engage the parking brake before watching moving video.

NOTE

The Video Blocking system under Parking Brake **NOT ENGAGED** only control this unit's display. This system will not affect the Video Output thru the rear RCA Video Output.

TIPS

Be sure to connect Parking Brake connection lead. (please see more details on " Wiring Diagram.")

NOTE

If watch moving video from Disc or AV In source but Parking Brake is **NOT PROPERLY CONNECTED**, the video signal will be blocked by the system and the below display will be show on TFT:



Video Blocked
Engage Parking
Brake to enjoy video

About The Reverse Wire For Back Up Camera System

If user connected a back up camera system to this unit, when the vehicle is in reverse Gear (Back Up mode), the front in-dash TFT display will automatically switch to Back Up Camera Video signal regardless whatever mode is currently displayed on the front in-dash TFT.

Tips

Be sure to connect Reverse wire properly. (please see more details on " Wiring Diagram.")

CONNECTING THE SYSTEM

Wiring Diagram

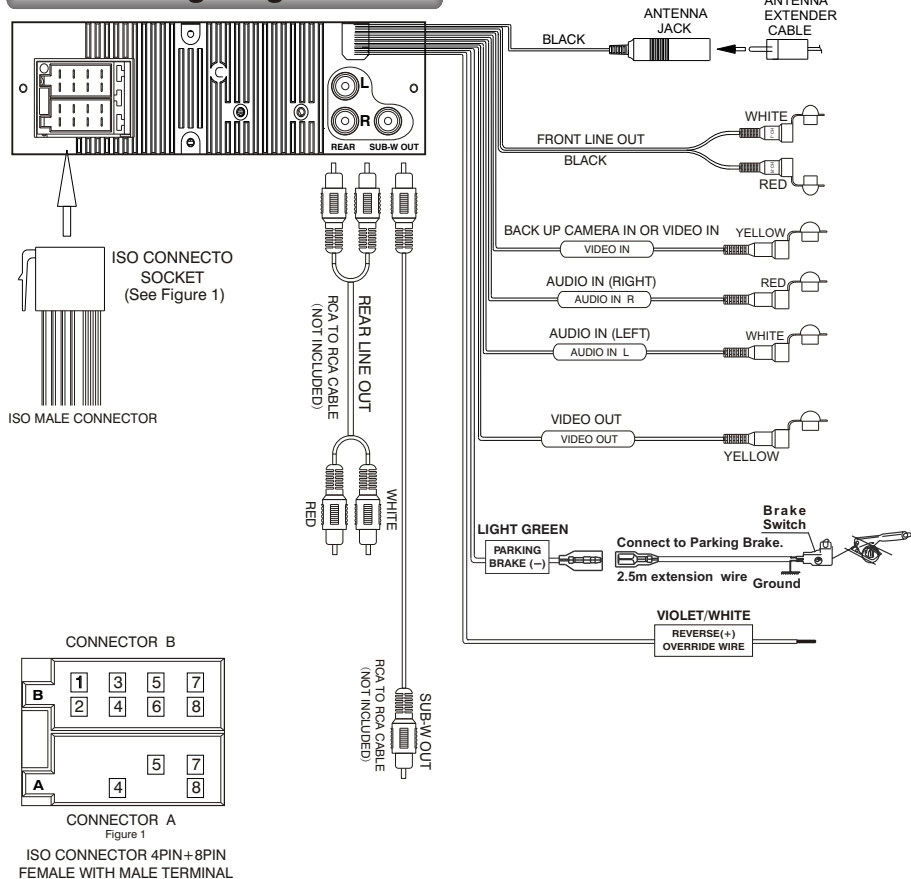

ISO CONNECTOR WIRING CHART





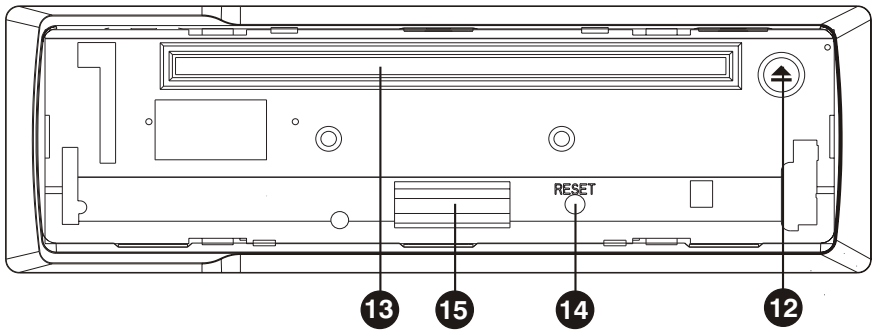
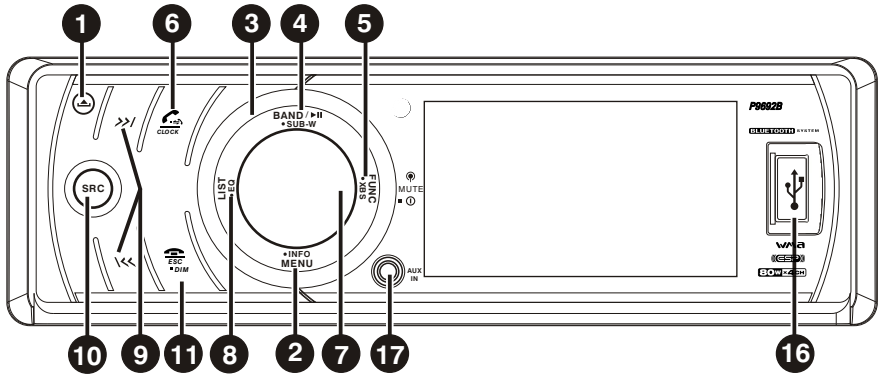

PIN	WIRE COLOR	FUNCTION/LABEL
A4	YELLOW	CONSTANT POWER(+)
A5	BLUE/WHITE	REMOTE AMP WIRE(+)
A7	RED	ACCESSORY POWER(+)
A8	BLACK	GROUND(-)
B1	VIOLET	RIGHT REAR SPEAKER (+)
B2	VIOLET/BLACK	RIGHT REAR SPEAKER (-)
B3	GREY	RIGHT FRONT SPEAKER (+)
B4	GREY/BLACK	RIGHT FRONT SPEAKER (-)
B5	WHITE	LEFT FRONT SPEAKER (+)
B6	WHITE/BLACK	LEFT FRONT SPEAKER (-)
B7	GREEN	LEFT REAR SPEAKER (+)
B8	GREEN/BLACK	LEFT REAR SPEAKER (-)

THE FUNCTIONS OF MAIN UNIT



No.	Item	Decriptions
1	(RELEASE)	▶ Press this button to open the control panel.
2	MENU	▶ Press this button to access into the SystemMenu mode.
3	INFO	▶ Under DVD playback mode, press repeatedly to view play information: Title--->Chapter--->Play time
3	ENCODER VOLUME	▶ Rotate the Encoder Volume Knob to increase and decrease the volume. (The Maximum volume level is "46".)
4	BAND/	▶ Under Tuner mode, short press this button to change between BAND FM1, FM2, FM3, AM1(MW1) (or AM2 (MM2) if available).
4	SUB-W	▶ Under Media playback mode, short press this button to Pause/ Resume Play the music.
4	SUB-W	▶ Press and hold this button to turn On/Off the subwoofer function.
5	FUNC (FUNCTION)	▶ Press this button to enter into the Function mode.
5	XBS	▶ Hold & press this button to turn On/Off the Bass booster function.

THE FUNCTIONS OF MAIN UNIT





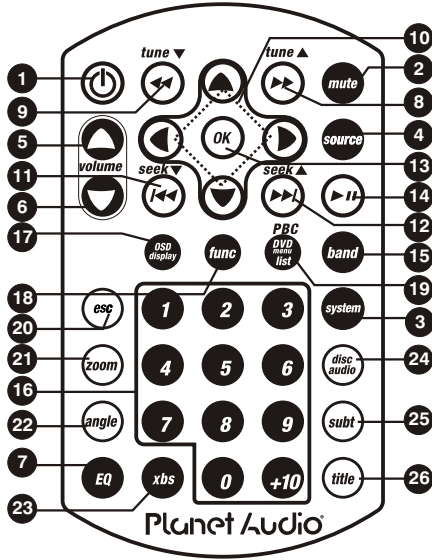













6	 CLOCK	▶ Press this button to view the Clock, press this button again to return to previous mode.
	 DIAL	▶ Under the Bluetooth Handfree mode, short press this button to answer an incoming call.
	 TRANSFER	▶ Under the Bluetooth Handfree mode, long press this button to enter into call Transfer back to Mobile Phone.
7	MUTE	▶ Short press this button to turn Mute or restore volume.
	 POWER	▶ Press this button or any other button on the front panel (except Release button) to turn the unit on. Hold & press this button again to turn the unit off.
8	LIST	▶ Under tuner mode, press this button to Show The List of stored station.
		▶ Under the Media playback mode, press this button to list the searching of Tracks or Files on the Media playback mode.
		▶ Under the DVD/MP4 mode, press this button to list the searching of DVD Root Menu or Files on the playback mode.
	EQ	▶ Under the VCD mode, press this button to turn On/Off the PCB function.
9	TUNE UP/DOWN	▶ Hold & press this button to select the Preset Equalizer setting.
	FILE UP/DOWN	▶ Under tuner mode, press and hold this button momentarily to enter into the Auto Seek/ Manual Seek mode.
	FAST BACKWARD / FORWARD	▶ Under media playback mode, press these buttons to skip a chapter / track / scene / file.
10	SOURCE	▶ Under media playback mode, press and hold momentarily to fast forward / backward the Disc.
11	ESC	▶ Press this button to select different source playback mode: TUNER / DISC / USB / SD CARD / BT AUDIO / AUX-IN
	DIM	▶ Press this button to quick return previous menu or mode.
		▶ Hold & press this button to adjust the TFT dimmer High or Low.
12	 EJECT	▶ Under the Bluetooth Handfree mode, press this button to end or reject an incoming call.
13	DISC SLOT	▶ Press this button to eject the Disc.
14	RESET	▶ Insert the disc into CD slot. The CD will begin to play.
15	SD CARD SLOT	▶ User can reset the unit to its default setting. Press this button by using a ball-point pen or sharp object.
16	USB SLOT	▶ This unit can support playback MP3/WMA/JPEG/MPEG4/DIVX format which are stored on the SD Card.
17	AUX-IN JACK	▶ This unit can support playback MP3/WMA/JPEG/MPEG4/DIVX format which are stored on the USB memory stick.
		▶ This unit is allowed to connect with external Audio system such like MP3 Player or hand phone. User can connect the external Audio system thru the Aux-In jack on front panel.

THE FUNCTIONS OF REMOTE CONTROL



No.	Button	Item	Decriptions
1		POWER ON OFF	Press this button to turn On / Off the unit.
2		MUTE	Press this button to turn the Mute On / Off.
3		SYSTEM MENU	Hold & press this button to enter into the System Menu mode.
4		SOURCE	Press this button to enter into the SOURCE mode.
5		VOLUME +	Press this button to increase the volume.
6		VOLUME -	Press this button to decrease the volume.
7		EQ	Press this button to enter into the preset Equalizer setting mode.
8			Under the tuner mode, press this button to access the Manual Seek mode. Under the media playback mode, press this button fast forward through the music under media player mode.
9			Under the tuner mode, press this button to access the Manual Seek mode. Under the media playback mode, press this button fast backward through the music under media player mode.
10		UP/DOWN LEFT/RIGHT	Use these buttons to move cursor up/down/left/right.

THE FUNCTIONS OF REMOTE CONTROL

11			Under the tuner mode, press this button access Auto Seek mode. Under the media playback mode, press this button to skip backward of the previous chapter.
12			Under the tuner mode, press this button access Auto Seek mode. Under the media playback mode, press this button to skip forward of the next chapter.
13		OK	Use this button to confirm the selection.
14		PLAY/PAUSE	Press this button to Pause / Resume Play the music under media playback mode.
15		BAND	Press this button to return previous menu. Under the tuner mode, press this button to change the radio Band.
16		NUMERIC BUTTONS	When in media playback mode use this button for track or file number direct access and use when function need numeric selection or input.
17		MultiMedia DISPLAY	Press this button and the information displayed on the TFT may vary according to this disc or files type.
18		FUNCTION	Press this button to enter into the function mode.
19		LIST	Under tuner mode,press this button to Show The List of stored station. Under the Media playback mode, press this button to list the searching of Tracks or Files on the Media playback mode. Under the MultiMedia/MP4 mode, press this button to list the searching of MultiMedia Root Menu or Files on the playback mode. Under the VCD mode, press this button to turn On/Off thePCB function.
20			Press this button to quick return previous menu or mode.
21		ZOOM	When playback the MultiMedia, press this button repeatedly to increase the magnification level.
22		ANGLE	Under MultiMedia mode, press this button while playing a scene recorded with multiple angles to change the angle.
23		IX-BASS	Press this button to turn On/Off the iX-BASS booster function.
24		DISC AUDIO	Under MultiMedia mode, press this button during playback to change the audio language, if available on the disc.
25		SUBTITLE	Under MultiMedia mode, press this button during playback to turn on/off subtitles and change the subtitles.
26		TITLE	Under MultiMedia mode, press this button to bring up the Title Menu.

ADJUST SETTINGS

Press the MENU/INFO button access into the System Menu. User can rotate the Encoder Volume Knob to select the below options, then press Power/Mute to confirm.

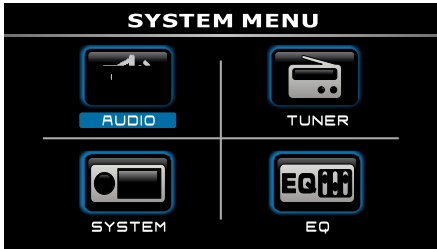

Adjust Audio Setting

User can rotate the Encoder Volume Knob to select the below Audio Settings, then press Power/Mute to confirm.

▶ Bass

User can use the Encoder Volume knob to adjust the desired Bass level range from -6 to +6.

▶ Treble

User can use the Encoder Volume knob to adjust the desired Treble level range from -6 to +6.

▶ Fader

User can use the Encoder Volume knob to adjust the Fader between the front and rear speakers from 12R (full rear) to 12F (full front).

▶ Balance

User can use the Encoder Volume knob to adjust the Balance between the right and left speakers from 12R (full right) to 12L (full left).

Tuner Setting

User can rotate the Encoder Volume Knob to adjust the Tuner Settings, then press Power/Mute to confirm.

▶ Tuner Area

This option allows the selection of the frequency spacing appropriate for your area. Rotate the Encoder Volume Knob to select the Tuner Area: U.S.A, Europe, Oirt, Latin.

Adjust System Setting

User can rotate the Encoder Volume Knob to select the System Settings, then press Power/Mute to confirm.

▶ Beep Tone

To adjust the Beep Tone On/Off. The beep tone feature allows the selection of an audible beep tone to be heard each time a button is pressed on the face of the radio.

▶ Time Set

The time on the clock will be set to 12:00 as the default. User can rotate the Encoder Volume Knob to adjust the HOUR / MINUTE.

Preset Equalizer Setting

Under the Preset EQ Setting, there are the below 8 different types of preset equalizer available for user selection.

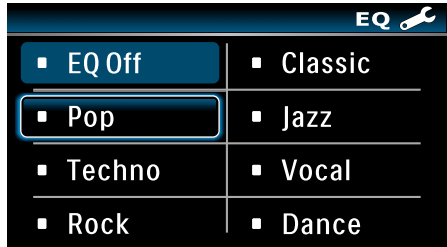

TIPS

Press and hold LIST button on the front panel is to quick get into the Preset Equalizer Setting menu.

TUNER OPERATIONS

Adjust Tuner Function

Press the FUNC button under Tuner mode access into the Tuner Function menu. User can rotate the Encoder Volume Knob to select the below options:

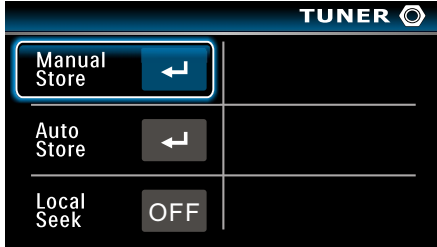

▶ Manual Store

Use this function to save the current frequency to memory stations. User can press the Power/Mute to enter into the manual store memory stations.

▶ Auto Store

After Auto Store & saved the 6 strongest stations, the unit will automatically enter present scan one time.

▶ Local Seek

To receive more radio stations or only stations with strong signal, you can adjust the tuner sensitivity. User can press the Power/Mute to turn On/Off the Local Seek mode.

[Local Seek On]: Only stations with strong signal can be broadcast.

[Local Seek Off]: Stations with strong and weak signals can be broadcast.

Tune To Radio Station

Press the BAND button to change between FM bands and AM(MW) bands.

Tune To Preset Station

Press the LIST button to get into the preset stations list, and user can use the Encoder Volume Knob to select which preset station he would listen to, and press the Power/Mute button to confirm the selection.

Manual Seek

Press and hold **◀◀/▶▶** buttons on front panel to access into the Manual Seek mode.

Auto Seek

Press and hold **◀◀/▶▶** buttons on front panel to access into the Auto Seek mode, and the unit will auto search for the next radio station.

MEDIA PLAYER OPERATIONS (Disc/USB/SD Card)



This unit can play various video / audio stored into Disc / USB or SD Card on media player.

You can play commercially available audio CDs and these Discs:

- Digital Versatile Discs (MultiMedias)
- Video Cds (VCDs)
- Digital Versatile Discs Recordable (MultiMedia+/-R)
- Digital Versatile Discs Rewritable (MultiMedia+/-RW)
- Compact Discs (CDs)
- CD Recordable (CD-R)
- CD Rewritable (CD-RW)

NOTE

Please ensure that the disc contains playable content.

1. Press  on the front panel to release the panel.
2. Insert a CD with the printed side facing up, then close the panel, the unit will play starts automatically.
 - Press the BAND/||| to pause the music play. Press this button again to resume music play.
 - Press the <<</>>> to skip forward to the beginning of the next or previous chapter.
 - Press and hold the <<</>>> to fast forward or fast rewind through the disc. Press these buttons again to resume normal playback.
3. Press  to take out the CD.

USB Device Operation

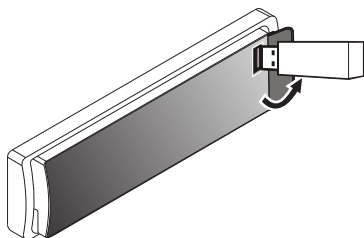

Flip open the USB plastic cover, insert the USB device into the USB socket. The unit starts playing from the USB device automatically.

NOTE

Ensure that the USB device contains playable music.

Memory Card Operation

▶ Insert The Memory Card

1. Press  on the front panel to release the panel.
2. After flipping down the front panel, push rightwards, then draw the left of the panel.
3. Insert the Memory Card into the card slot, then close the panel, the unit will play starts automatically.

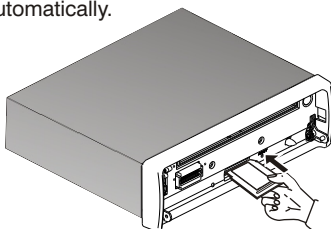

NOTE

Ensure that the memory card contains playable music.

▶ Remove The Memory Card

press the card until you hear a click sound, the card is now disengaged. then remove the card.

Media Playing

▶ Repeat

During the media playback, press the FUNC button to adjust the different Repeat mode.

For MULTIMEDIA/VCD mode

- [Repeat CH]: repeat playback the current the chapter.
- [Repeat TT]: repeat playback the current title.
- [Repeat Off]: cancel all the repeat function.

For MP3/WMA/CD mode

- [Repeat Off]: play all tracks repeatedly
- [Repeat One]: play the current track repeatedly
- [Repeat Folder]: play all tracks in the current folder repeatedly

Random



User can play audio tracks/files or VCD videos in random order. During the playback, press the FUNC button to turn On/Off the random function.

MEDIA PLAYER OPERATIONS (Disc/USB/SD Card)

Skip/Search

1. Under the Media playback, press the LIST button access into the playlist menu. User can rotate the Encoder Volume Knob to select the below options:



-  : to display all available audio folders / track.
-  : to display all available pictures folders / files.
-  : to display all available video folders / files.

2. Under the MultiMedia playback mode, press the LIST button can access into the MultiMedia Root Menu.

Audio Channel

During the VCD playback, press the FUNC button access into the Channel mode. Press the Power/Mute to select the available audio channels provided by the disc (Stereo, Left, Right).

PBC Playback

PBC playback allows you to play Video CDs interactively. During the VCD playback, press the FUNC button access into the Pbc mode, press the Power/Mute to turn PBC On or Off.

[PBC On]: it will switch to OFF and continue playback.

[PBC Off]: it will switch to ON and return to menu screen.

TIPS

Press the LIST button on the front panel is quick to turn the PBC On or OFF.

Video Setting

Under MultiMedia/VCD playback, press the FUNC button access into the Video Setting mode, the below Setup menu will appear:



- **[BRIGHT]:** change the Bright level from 0 to 7.
- **[CONTRAST]:** change the Contrast level from 0 to 7.
- **[COLOR]:** change the Color level from 0 to 7.
- **[Reset]:** reset to default setting.

MULTIMEDIA Audio

During the MultiMedia playback, press the FUNC button access into the MultiMedia Audio to change the audio language (MultiMedia only).

Subtitle Language

During the MultiMedia playback, press the FUNC button access into the Subtitle to turn On/Off subtitles and change the subtitles (MultiMedia only).

Angle

Under the FUNC menu, user can press Aangle while playing a scene recorded with multiple angles to change the angle (MultiMedia only).

Aspect Ratio

The TV Aspect setting allows the user to select the aspect ratio of the TV (MultiMedia and VCD only).

Under the FUNC menu, user can use the Encoder Volume Knob to select the following options:

4:3=Aspect ratio of TV is 4:3

16:8=Aspect ratio of TV is 16:9. Both wide screen and 4:3 contents will fill the entire screen.

Aux-In Mode

Select the AV Mode

Your can connect up to 1 AV device, press the SOURCE button to enter into the Aux-In mode:

Aux - 1 IN = Front panel Aux in

AV - 2 IN = RCA back of unit

Aux -1 In

This unit is allowed to connect with external Audio/Video system such like Digital Camera or Game Console. User can connect the external Audio/Video system thru the Aux-In jack on front panel.

Connect the Aux-In

Connect the external signal to Aux-In jack located at the front of the panel, then press Source button to select Aux-In mode. Press Mode Button again to cancel Aux-In mode and retrun to previous mode.

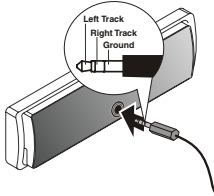

AV - 2 In

Connect the external signal to the RCA line in jack located at the rear of the unit, then press SOURCE button to select AV -2 In.

TIPS

If there is no any external AV System input, then the TFT will be show " NO VIDEO SIGNAL".

NO VIDEO SIGNAL

BLUETOOTH OPERATIONS

User Guide For Bluetooth

1. When using this Bluetooth HEAD UNIT, please make sure the mobile phone you use supports Bluetooth functions (Headset or Handsfree profiles or both).
2. Before you start to use the Bluetooth HEAD UNIT, please make sure you successfully paired your mobile phone with the system. Please refer to the user manual, section "PAIRING" for detail "PAIRING" instruction. To ensure the best reception for Pairing or Re-connection, please make sure the Phone Battery is fully charged when making the Pairing or Re-connection.
3. Always try pairing the Mobile Phone with Head unit after a few minutes of the Mobile Phone being switched on to ensure the best pairing result.
4. "CW80" is this unit device model number which is displayed on the mobile phone.
5. To achieve the best performance, please always keep the Mobile Phone within 3 meters of the Head unit.
6. Please always keep a clear path between the Mobile Phone & the Head unit.
7. Never put any metal object or any obstacle between the path of the Mobile Phone & the Head unit.
8. Some mobile phone brands like Sony Ericsson may have "Power Saving Mode" selection when Bluetooth mode is switch on. **DO NOT** Switch ON Power saving Mode when operating with this Head Unit, as some abnormal communicational behavior might occur.
9. Before the user makes an outgoing call or accepts an incoming call, make sure the mobile phone's "Bluetooth function" is switched "ON".
10. To ensure the best conversation quality / performance, talk within 1 meter of the Head Unit.
11. If the user wants to Dis-connect the Head unit with the Mobile Phone, please switch "OFF" Bluetooth connectivity on the Mobile Phone.
12. Some Mobile Phones can support "IN BAND RING TONE", such as Nokia. In such case, the Incoming Ringing Tone will be same as the original Ring-tone of the Mobile Phone. But some Mobile Phones like Sony Ericsson do not support this feature. The Ring-tone will be using the standard Ring-tone of the Head unit.
13. When in telephone mode, during talking, it is highly recommended to set the volume to below "35" in order to achieve the best sound quality. If the volume is too high, it may create unwanted echo inside the car. The unwanted echo may feedback into the microphone.

Frequency Asking Questions

Q: In a conversation, if the voice output from the car's speakers is not loud enough.

A: Try increasing the volume level of the head unit to a suitable sound level.

Q: During a conversation, if the "Listener" cannot hear my voice loud enough.

A: First, try asking the "Listener to" increase the volume level on his/her mobile phone, if it is still not loud enough, try to increase your mobile phone's volume level.

BLUETOOTH OPERATIONS

Q: Under Phone conversation, the “ Listener can hear echo feedback.

A: Your unit's speaker volume level is too loud which causes the voice feedback into the microphone. This can be corrected by decreasing the volume level.

Q: Under Phone conversation, your background is too noisy



A: May be you are in a noisy environment. Try closing the car's window to shield the environment/background noise under phone conversation.

Q: If the Mobile Phone already paired with the head unit, but after several calls, the incoming calls cannot access thru the head unit.

A: The paired Mobile Phone might have lost the Bluetooth connection with the head unit. In this case, please reconnect the Bluetooth connection to the Mobile Phone.

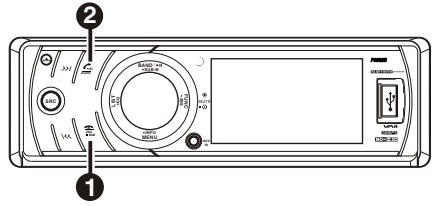
Name of Buttons and Their Functions



Button	Bluetooth Handfree Function
1 	Under an incoming call mode, press this button to end or reject an incoming call;
2 	Under an incoming call, short press this button to answer the call; Under the talking mode, long press this button to call transfer back to Mobile Phone;

BLUETOOTH OPERATIONS

Handsfree Operation

▶ Pairing The Bluetooth System Between Mobile Phone & The Unit

- Open your Mobile Phone and switch Bluetooth to on, and search Bluetooth device.
- “CW80” should appear in the pairing list on the Mobile Phone. User need to select “CW80” and then input the password “1234”. If the pairing is successful, the below display will show on TFT for a while:

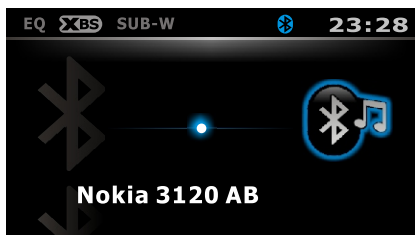

and the unit will switch back to the previous mode automatically.

▶ Disconnecting of the Bluetooth System

Open your Mobile Phone and disconnect the Bluetooth System with the unit.

- If the Disconnection is successful, the below display will show on TFT:

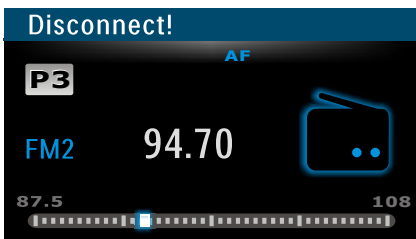

and the unit will switch back to the previous mode automatically.

▶ Answering An Incoming Call

- When there is an incoming call, the display will show the Phone Number. If the incoming call has no caller I.D. number, the LCD will display “Phone In”, user can short press the button to answer / accept the call.

- User can use the Encoder Volume Knob to adjust the volume level.
- To end the conversation, press the “” button. The unit will switch back to the previous mode automatically and release the mute of the previous mode at the same time.

NOTE

An Incoming call under stand by mode (Ignition on & Power Off), the system will automatically switch on the head unit.

▶ Rejecting An Incoming Call

User can press “” button to reject the incoming call.

NOTE

The audio output of the present mode will be muted and the ringing tones will be heard if an incoming call is not being answered. After pressing the “” button, the mute of the present mode will be released.

▶ Making An Outgoing Call

- User can use his / her Mobile Phone to dial and make an outgoing call. Once the user has completed the dialing, the below display will show on TFT:

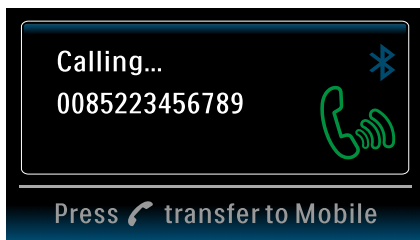



- User can use the Encoder Volume Knob to adjust the volume level.
- To end the conversation, press the “” button. The unit will switch back to the previous mode automatically. The mute of the previous mode will be released at the same time.

BLUETOOTH OPERATIONS

► Call Transfer

During the talking mode, user can long press the “” button to transfer the audio from the unit back to the Mobile Phone for privacy reason.

NOTE

- After the “” button is pressed, the present mode will be muted at the same time, user can press the  button to release the Mute.
- When making an outgoing call, it's not possible to CALL TRANSFER if the call is not being answered yet. It's only possible to Transfer the call to Mobile Phone after the call is being answered.
- Depending on different type of Mobile Phone, the time need for activating the CALL TRANSFER mode is different. Example Nokia Mobile Phone usually takes 3-5 seconds after pressing the “” button for audio transfer back or forth from Unit to Mobile Phone.

BLUETOOTH OPERATIONS

Bluetooth Audio Operation

User can listen to music files on an audio device on this unit if the audio device supports A2DP (Advanced Audio Distribution Profile) of Bluetooth Technology. Please read the below instruction before operating the Bluetooth Audio streaming function on this unit.

▶ Connecting A Bluetooth Audio Device With This Unit

Before using an audio device to play music on this unit, the audio device must be paired with this unit first.

- Open your Mobile Phone and switch Bluetooth to on, and search Bluetooth device.
- “CW80” should appear in the pairing list on the Mobile Phone. User need to select “CW80” and then input the password “1234”. If the pairing is successful, the below display will show on TFT for a while:

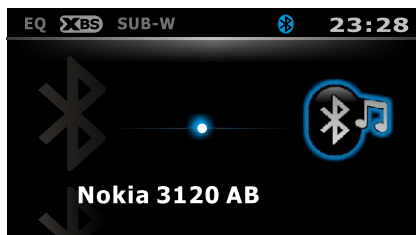

and the unit will switch back to the previous mode automatically.

TIPS

If the audio device has both HFP (Hands Free Profile) and A2DP (Advance Audio Distribution Profile), this unit will automatically pair these two profiles at the same time. For example: if a mobile phone has both HFP & A2DP profile and this mobile phone is already HFP paired with this unit, A2DP audio device pairing is not necessary. Also this paired mobile phone will be added automatically to the list of Paired Device – Audio of this unit.

▶ Listening To Music From An Audio Device In This Unit

1. Connect this unit with the audio device.

NOTE

Make sure the Bluetooth system is connecting with this unit. If the “BT” icon on the TFT is blinking, it means the Bluetooth is disconnected with this unit. Open your Mobile Phone or Audio device to re-connect Bluetooth again.

2. Press SOURCE button repeatedly until BT AUDIO appears on the TFT.

IMPORTANT

To listen to Bluetooth audio streaming from the audio device, user MUST change the mode to “BT AUDIO” first. Any other mode of this unit is not able to activate the Bluetooth audio streaming (A2DP) function.

NOTE

In Bluetooth Audio Mode, if there is no audio device connected with this unit, the TFT will show “BT AUDIO”.

The unit will search for an audio device for 20 seconds. If there is no device found, the screen will display “NO DEVICE”

3. Once in the “BT AUDIO” mode, user can use the audio device to start playback via Bluetooth wireless with this unit.

NOTE

When you change to Bluetooth Audio mode, some audio devices will automatically start playback. Some phones may require you to choose 'Media Player' mode on your phone.

If the auto playback is not supported on the audio device, please refer to the instruction manual for the audio device on how to operate music playback via Bluetooth wireless technology.

BLUETOOTH OPERATIONS

▶ **Operating an audio device with this unit AVRCP (Audio Video Remote Control Profile)**

This unit can perform the following operations when the connecting Audio device supports AVRCP (Audio Video Remote Control Profile) only if the Audio device supports AVRCP.

1. Start playing - Every time the user switches to "BT AUDIO" mode, this unit will automatically send a "PLAY" command via AVRCP to the audio device to command the auto start playing song in the audio device.

NOTE

The PLAY command may differ depending on the Audio device. If the Audio device is not able auto start playing after changing mode into "BT AUDIO" mode, user may need to operate the PLAY mode on the audio device to start the song playback.

2. Track up / down - by pressing the Track up / down buttons on this unit.
3. Pause/Play - by pressing the Pause / Play button on this unit.
4. Encoder Volume - by rotating the Encoder volume knob on this unit.
5. Audio Mute - by pressing the Mute button on this unit.
6. Stop playback - by changing mode into any other mode of this unit.

NOTE

The AVRCP operation may differ depending on the audio device.

▶ **Handsfree Phoning While Bluetooth Audio Streaming**

If the connecting playback audio device is a mobile phone, all the hands free function is still available under the Bluetooth audio streaming, like the answering incoming call, making an outgoing call, etc.

▶ **Disconnecting An Audio Device With This Unit**

User can close the Bluetooth Audio connection by disconnecting with the audio device on the Mobile Phone.

NOTE

For more detail and information on disconnecting with the unit, please refer to the DISCONNECTION section.

SPECIFICATIONS

TFT Screen Section

Screen Size: 3.2" (Measured Diagonally)
Screen Type: TFT Liquid Crystal Display active matrix
Resolution: 320 x 240

MultiMedia / CD Section

Compatible Disc/Format	See " Disc Note" for more details description
Signal to Noise Ratio	≥ 90 dB
Dynamic Range	≥ 90 dB
Frequency Response	20Hz to 20Khz +/-3dB
Channel Separation	2 Channel (Stereo) >60dB @1khz

Video Section

Color System	NTSC / PAL/SCEAM
Video Output	Composite 1.0 Vp-p (+/- 0.2) 75 - ohm
Video Input	Composite 1.0 Vp-p (+/- 0.2) 75 - ohm

Audio Section

Max Output Power	80W x 4 channels
Load Impedance (speakers)	4 ohms
Line out level / load	400mV / 10k ohm load
Line out Impedance	200 ohm

Auxiliary Input Section

Frequency response	20Hz to 20KHz -3dB
Input Maximum Voltage	1200 mV
Input Impedance	4.7k ohm

Radio Section

FM

Frequency Range	87.5-107.9 MHz (U.S.A) 87.5-108.0 MHz (Europe)
Usable Sensitivity	≤ 15dB at S/N 30 dB
Stereo Separation	25 dB at 1KHz
S/N Ratio	50 dB

AM or MW

Frequency Range	530-1720 (U.S.A) 522-1620 Khz (Europe)
Usable Sensitivity	< 40dB at S/N 20dB
S/N Ratio	40 dB

BLUETOOTH

Power Consumption	200mA Max.
Output Power	0 dBm (Class II)
Frequency Band	2.4GHz ~ 2.4835GHz ISM Band
Range	3 meters (free space)
Standard	Bluetooth 2.0 specification

General

Operating Voltage	DC 11 -14.4V
Grounding System	Negative Ground
Fuse:	15-Amp Mini ATM Type
Operating Temperature:	0 °C to 50 °C 32 °F to 122 °F
Unit Mounting Angle	≤ 30°

TROUBLESHOOTING

Before going through the check list, check wiring connection. If any of the problems persist after check list has been made, consult your nearest service dealer.

Symptom	Cause	Solution
No power	The car ignition is not on.	If the power supply is properly connected to the car accessory terminal, switch the ignition key to "ACC"
	The fuse is blown.	Replace the fuse.
Disc cannot be loaded or ejected	Presence of CD disc inside the player.	Remove the disc in the player, then put a new one.
	Inserting the disc in reverse direction.	Insert the compact disc with the label facing upward.
	Compact disc is extremely dirty or defective disc.	Clean the disc or try to play a new one.
	Temperature inside the car is too high.	Cool off or until the ambient temperature returns to normal.
	Condensation.	Leave the player to off for an hour or so, then try again.
No sound	Volume is in minimum.	Adjust volume to a desired level.
	Wiring is not properly connected.	Check wiring connection.
The operation keys do not work	The built-in microcomputer is not operating properly due to noise.	Press the RESET button. Front panel is not properly fixed into its place
Sound skips.	The installation angle is more than 30 degrees.	Adjust the installation angle to less than 30 degrees.
	The disc is extremely dirt or defective disc.	Clean the compact disc. Then try to play a new one.
The radio does not work. The radio station automatic selection does not work.	The antenna cable is not connected.	Insert the antenna cable firmly.
	The signals are too weak.	Select a station manually.
ERROR	Mechanism Error	Press the eject button to correct the problem. If the error code does not disappear, consult your nearest service dealer.
Disc Error	Maybe disc dirty / disc scratched /disc upside down.	Replace the disc.



If at any time in the future you should need to dispose of this product please note that Waste electrical products should not be disposed of with household waste. Please recycle where facilities exist. Check with your Local Authority or retailer for recycling advice.(Waste Electrical and Electronic Equipment Directive)